

Operation Manual

BLR-CX (MB_EN_ACX-R_BEL_10)



ATTENTION!

Installation of the BLR-CX must only be undertaken by technically qualified persons, since live terminals can cause electric shock.

The appropriate safety regulations in the country of installation must be strictly adhered to.

Equipment with damaged casing or terminals must not be used and must be disconnected from the mains supply immediately.

Beluk GmbH
Taubenstrasse 1
86956 Schongau
Germany

Phone: 08861/23320
Fax: 08861/23322
blr@beluk.de
<http://www.beluk.de>

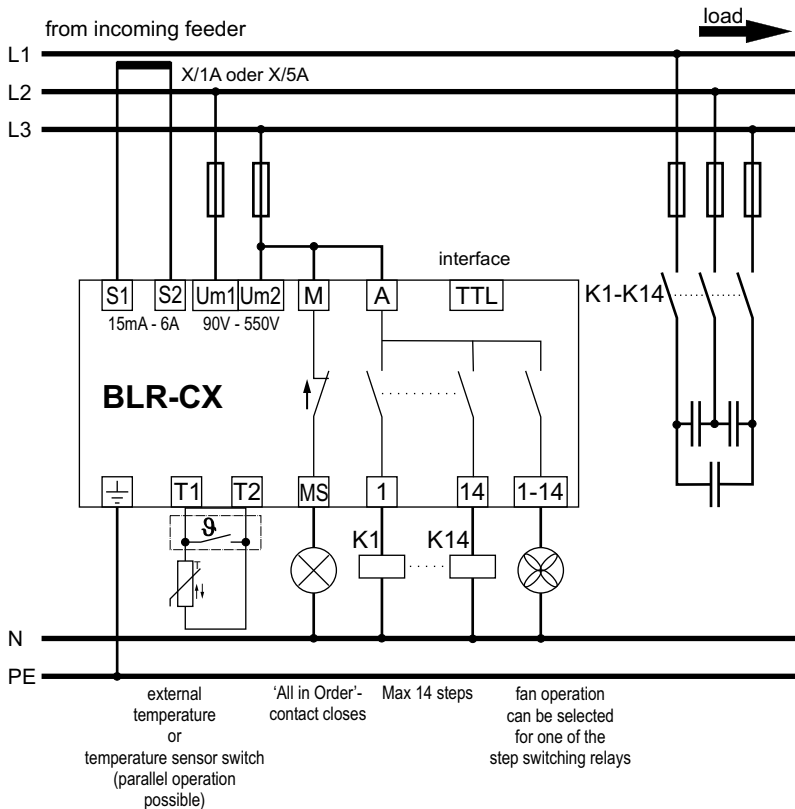

Installation and Commissioning:

- 1) Check that the mains voltage and CT current input are suitable for the relay!
- 2) Disconnect panel from mains voltage, and check that the voltage is off
- 3) Ensure CT short-circuited or not in operation.
An open circuit CT produces a high voltage which endangers people and equipment. It will also damage the CT and affect its accuracy.
- 4) Disconnect and remove any previous pfc-relay.
- 5) Mount BLR-CX in the control panel with the two mounting clips. (cutout 138x138mm)
- 6) Connect the earth protection cable to 'PE' on BLR-CX metal case.
- 7) Connect BLR-CX according to wiring diagram. (CT/P1 towards incoming feeder, CT/P2 towards load!)
- 8) Remove short-circuit from CT
- 9) Connect mains voltage to panel.
- 10) If relay has been correctly connected and the mains voltage and CT output comply with the ratings and settings of BLR-CX, the LCD will show **AUTO** and the control function will start automatically!

FAQ during Commissioning:

- 1) **No indication AUTO** → the relay does not switch
Cause: Relay set to manual operation
In SETUP/100 menu the selection for PFC is on OFF or HOLD
temperature is too high,
current < 15mA, voltage or THD U is out of tolerance.
- 2) **Indication U ALARM** → voltage out of tolerance
Check settings for nominal voltage (SETUP/Un) and
voltage transformer (SETUP/Pt)
- 3) **Indication I Lo ALARM** → CT current < 15mA
Cause: connection error of CT; short-link of CT is not removed;
CT-ratio is too high compared to real current; no current
- 4) **Indication EXPORT** → kW export
if there is no real kW export, voltage and current connection to
BLR-CX has to be checked! See Wrong Connections / AI
- 5) **Wrong Cos φ indication** → wrong connection
voltage and current connection to BLR-CX has to be checked!
See Wrong Connection / AI
- 6) **Steps switch in and then quickly switch out again**
See Stepsize Detection / Defective Capacitors
- 7) **Frequent switching of steps**
size of capacitors has not been completely detected

Display:



INFO: step database information

AUTO: relay is working in AUTO mode

MANUAL: relay is working in manual mode

SETUP: Setup of parameters



EXPORT: kW export

NT: 2nd target-cos ϕ is working

ALARM: blinking during alarm

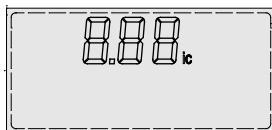

1. line:

cos ϕ

menu items

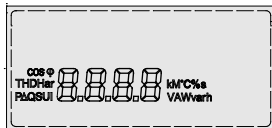

2. line:

measuring values

parameters

alarm codes



Step indication:

state of step (on/off)

step defective (blinking)

Handling:

BLR-CX has 4 keys for navigation and input of parameters.

exit menu
move cursor left
reset alarm
(hold for 5 sec)

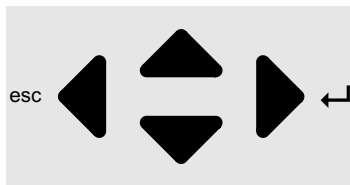

increase values
select menu items

Decrease values
select menu items

open menu
move cursor right
confirm input

Input parameter:

- ▲, ▼ setting of number
- ▶ selection of next digit
- ▲, ▼ after setting of last digit, selection of:
 - multiplier **k** (kilo) or **M** (Mega)
 - leading sign **I** (inductive) or **C** (capacitive) (blinking of I or C)
- ▶ storage of setting
- ◀ abort input

Main Menu:

Select menu items by pressing ▲, ▼, enter submenu by pressing ►

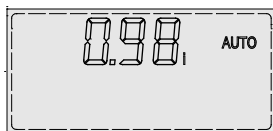

Measuring Values: (selected using ▲, ▼)

U_{LL} , U_{LN} , A (I), kW (P), kVar (Q), Δ kVar (Δ Q),
kVA (S), THD U, 3. -19. Har. U, $\cos\phi$, Λ (PF),
 $\phi\Lambda$ (APF), $\tan\phi$ (tAn), Hz (F), °C(t), °Cmax (thi),
operation hours (OPh)

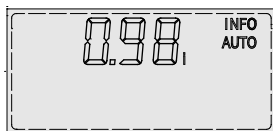

INFO Step Database:

size and derating of steps,
switch cycles, steptype
(see INFO Step Database)



MANUAL Operation:

Selective switching in and out of control exits
(see MANUAL Operation)

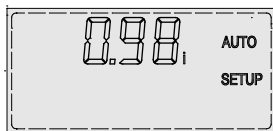

SETUP Parameters:

Nominal voltage (U_n), CT-ratio C_t , VT-ratio (Pt),
Automatic Initialising (Ai), PFC ON/OFF/HOLD
(PFC), target- $\cos\phi$ (CP1), switch time delay
(St), steptype (Out)
(see SETUP Parameters)

INFO Step Database:

Attention: Actual state of control outputs is not shown!

Choose step by ▲, ▼ and enter by ► . The selected step is blinking. By using ▲, ▼ following information can be selected:

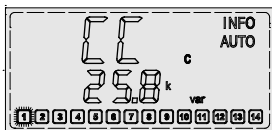

Actual Size of Capacitor

the value is rated to nominal voltage

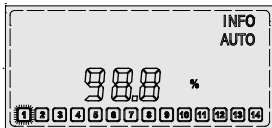

Derating of Capacitor:

present kvar value / original kvar value in %

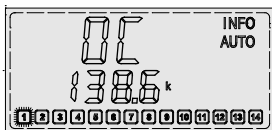

Switch Cycles of Contactor:

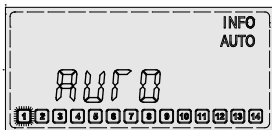

Step Setting:

AUTO: automatically switched step

Fon: step is permanently switched on

Foff: step is permanently switched off

AL: step used for fan control

FLty: defective step

MANUAL Operation:

For manual operation ► has to be pressed for 3 seconds!

Selection of step by ▲, ▼. Number of selected step is shown in line 2 of LCD. By pushing ► selected step will switch on / off.

Manual operation escape by pressing ◀ .

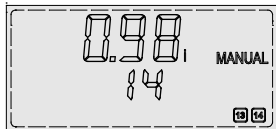

Important Information:

- Menu Manual Operation cannot be opened in modes LIFO and Combi-Filter. (see Reference book!)
- Discharging lockout time is also active during manual operation (steps are locked in to allow for discharge time after switching-off)
- If voltage is out of tolerance all steps are disconnected.
- THD U-alarm and over temperature alarms will prevent steps switching in on manual mode.
- Only steps with step type AUTO can be switched!
- After leaving manual operation menu, relay switches to the actual load.

SETUP Parameters:

Choosing SETUP, sub menu 100 is indicated. Pressing ► opens menu 100.
▲, ▼ menu 200-600 (protected by pin, see reference book)

Un Nominal voltage (very important!)

OV / UV monitoring, reference for step database.

Ct CT-ratio

indication of measuring values. (enables many measuring values)

Pt VT-ratio

important base for nominal voltage

AI Automatic Initialising

see wrong connection / AI

PFC PFC ON / OFF / HOLD

on, off, freezing of automatic pfc-correction

CP1 Target-cos ϕ 1

base for compensation target

St Switch time delay of each step

definition of speed of regulation

OUt Step type

definition of step type: AUTO, Fon, Foff, AL
reset of defective steps (FLty)

Wrong Connection / Ai - Automatic Initialising:

A pfc-relay demands correct connection of voltage and current (polarity and phase) to function correctly. If this is not the case, the connection must be corrected. As this is not always possible, BLR-CX is offering the following possibilities:

Manual Correction: SETUP / 200 see Reference book

Automatic Initialising: SETUP/ 100 / Ai

Ai is connecting and disconnecting all control exits several times by switching them on and off. This lasts several minutes! Exits which are not connected are designated as Foff (permanently off). Stepsizes are not detected by this function!

After Ai is complete, the BLR-CX has to be checked for correct operation!

Requirements for successful operation of Ai:

- voltage is within tolerance
- CT is connected (no simulation!)
- capacitor banks are installed and fuses are inserted

Possible problems for function of Ai:

- load variations
- small current signals (big CT-ratio, small stepsizes)

Failure indication Ai / Abrt:

Ai is aborted, as no clear result could be achieved, PFC = OFF.

Step Size Detection:

At each switching operation, step size is measured (except this function is not active SETUP / 300 see Reference book)

Setting of c/k value is not necessary. Switching sequence is carried out automatically by selecting capacitor steps with the most suitable kvar value to match the load requirement.

The recognised values are stored in a step data base. Loss of output of each capacitor step can be seen there.

If a step fails to function during the first 3 switching operations after a reset of the step data base, steptype **Foff** is set automatically.

Defective Steps:

When a step is switched 3 times in series without measured size, it is detected as defective and it is blocked for 24h.

Step state: flashing

Status: Flty, step is blocked

Failure analysis:

After commissioning, all steps have step type Foff:

Is short link of CT secondary removed?

Is position of CT correct?

Are all fuses present and in order?

In normal operation, one or more steps are flashing?

Check condition of fuses, contactors and capacitors of this faulty step.

Reset in SETUP / 100 / OUt or by re-start (interruption of supply voltage) of BLR-CX!

Alarms:

Settings of alarm system: SETUP / 500 see Reference book

| | | |
|------------------|----------------|---|
| U | ALARM : | Voltage out of tolerance |
| I LO | ALARM : | Current < 15mA (check current path) |
| I Hi | ALARM : | Current > 6A. (CT rating is too small) |
| PFC | ALARM : | Target cannot be reached (check panel) |
| HAr | ALARM : | Limit of THD U is exceeded |
| StEP/FLtY | ALARM : | Defective steps |
| SPL/Nr | ALARM : | Derating of stepsize (< 70% of original size) stepnumber and code are flashing in rotation |
| thi | ALARM : | Over temperature - disconnection of steps |
| OPH | ALARM : | max. operation hours are reached (maintenance) |
| OPC/Nr | ALARM : | max. switch cycles per step (maintenance) stepnumber and code are flashing in rotation |
| AI/Abrt | ALARM : | Abort of automatic initialising Start AI again at more quiet load conditions or do manual setting of phase offset (SETUP / 200 see Reference book) |

Factory Default Settings when delivered by Beluk

SETUP / 100 - for user

(open access-no password needed)

Important paramters

| | |
|------|--------------|
| Un: | 400V |
| Ct: | 1 |
| Pt: | 1 |
| Ai: | (no setting) |
| PFC: | ON |
| CP1: | 1 |
| St: | 10s |
| OUT: | Auto |

SETUP / 200 - MEASURING

(locked access - password needed)

| | |
|-------------------------|--------------|
| 201/nominal voltage: | 400V |
| 202/CT-ratio | 1 |
| 203/VT-ratio: | 1 |
| 204/tolerance voltage: | 10% |
| 205/Ph-Ph/Ph-N: | (automatic) |
| 206/phase offset: | 0° |
| 207/Ai: | (no setting) |
| 208/countdown with Ai: | NO |
| 209/synchronising: | AUTO |
| 210/temperature offset: | 0°C |

SETUP / 300 - CONTROL

(locked access - password needed)

| | |
|---------------------------|-----------|
| 301/sensitivity: | 60% |
| 302/target-cosφ1: | 1.00 |
| 303/target-cosφ2: | i0.95 |
| 304/EXPORT cosφ2: | NO |
| 305/switch time delay: | 10s |
| 306/St step exchange: | 2s |
| 307/step exchange: | YES |
| 308/step recogn. off: | NO |
| 309/lock defective steps: | YES |
| 310/PFC: | ON |
| 311/Algorithm: | Automatik |
| 312/kvar offset: | 0kvar |
| 313/asymmetric St: | 1 |
| 314/Qcap steps off: | NO |

SETUP / 400 -STEP DATABASE

(locked access - password needed)

| | |
|--------------------------|------|
| 401/discharge lock time: | 75s |
| 402/nom. stepsize CT=1: | 5var |
| 403/step type: | Auto |
| 404/switch cycles: | 0 |

Factory settings from Beluk

SETUP / 500 - ALARM SETTINGS

(locked access - password needed)

| | |
|------------------------------------|-------|
| 501/Reset manual | NO |
| 502/THD U alarm | NO |
| 503/THD U limit | 20% |
| 504/THD steps off | NO |
| 505/delay time THD, temp2 | 60s |
| 506/l=0 freeze PFC | NO |
| 507/maintenance alarm | NO |
| 508/limit switch cycles | 262k |
| 509/limit operation hours | 65.5k |
| 510/target-cos φ 2 by DI=1 | NO |
| 511/DI=1 when T1/T2 closed | NO |
| 512/temperature alarm | NO |
| 513/temp1 limit | 30°C |
| 514/temp2 limit | 55°C |
| 515/control alarm | NO |
| 516/defective steps alarm | NO |
| 517/derating alarm | NO |

SETUP / 600 - RESET

(locked access - password needed)

| |
|----------------------------|
| 601/factory settings |
| 602/reset step database |
| 603/reset operation hours |
| 604/reset APF |
| 605/reset max. temperature |
| 606/reset alarm |
| 607/info software version |
| 608/change password |

Technical Data:

| | |
|-----------------------|--|
| Voltage: | 90-550V, 1ph., 50/60Hz, 6VA |
| Current: | 15mA-6A, 1ph., <1VA, |
| Control exits: | relay, N/C, common root 250V AC / 5A, 400V AC / 2A |
| Temperaturemeasuring: | by plug-in thermistor |
| Alarm contact: | relay, voltfree, N/C operated, 250V AC / 5A, 400V AC / 2A |
| Fan control: | using of control exit |
| Interface: | TTL, rear (standard) optional: RS485 Modbus, USB |
| Ambient temperature: | operation: -20°V - 70°C storage: -40°C - 85°C |
| Humidity: | 0% - 95%, without condensation |
| Overvoltage: | II, dirt class 3 |
| Connection: | screw type, pluggable |
| Case: | front: instrument case plastic rear: metal |
| Protection: | front: IP50, (IP54 by using a gasket) rear: IP20 |
| Weight: | ca. 0,6kg |
| Size: | 144x144x58mm hxwxh cutout: 138 (+0,5) x 138 (+0,5)mm |