



Reference Manual



Capacitor Protection Relay

KSR1



Table of content

1. Revision history	3
2. Safety notes	4
3. Overview.....	5
4. Application.....	6
4.1 Unbalance voltage monitoring	6
4.2 Unbalanced current monitoring.....	6
5. Terminals	7
5.1 Power supply	7
5.2 Inputs.....	7
5.2.1 Measurement input	7
5.2.2 Digital input.....	7
5.3 Outputs.....	7
5.3.1 Trip relay	8
5.3.2 Alarm relay.....	8
5.3.3 Relay 3.....	8
5.3.4 Status relay	8
6. Operation.....	9
6.1.1 Operation concept	9
6.1.2 Input of numerical values	10
7. Display indications.....	11
7.1 General	11
7.2 Error messages	11
8. Menus.....	12
8.1 INFO	12
8.2 SETUP.....	12
8.3 ALARM	16
9. Specifications.....	17
10. Settings	18



1. Revision history

Date	Name	Revision	Change
30.06.10	LE	1.0	Initial document release
07.09.10	LE	2.0	Editorial changes, Add technical data
02.12.10	LE	3.0	Add changed menu points
02.03.11	LE	4.0	Add additional explanations
29.11.11	LE	5.0	Content update
26.11.12	LE	6.0	Change factory settings
09.09.13	LE	07	Add dimension drawing
20.04.16	RH	08	Update current measurement
15.02.18	ChP	09	DQS-Logo removed
18.09.18	SMi	10	Layout changes
09.05.19	SMi	10.1	New revision numbering, graphics exchanged, layout adjustments, content improvements
24.06.19	SMi	10.2	Error message description



2. Safety notes

The following safety notes and instruction have to be read attentively and carefully. Familiarize yourself with the device before installation, commissioning and operation. The following symbols are found in the instruction manual and on the back of the device to indicate hazards and problems or to give specific instructions.

DANGER

DANGER indicates a dangerous situation which cause death or severe injuries if it is not avoided.

WARNING

WARNING indicates a dangerous situation which may cause death or severe injuries if it is not avoided.

CAUTION

CAUTION indicates circumstances which may damage or destroy the device in case of non-observance, but do not cause injuries.

NOTE boxes provide information about the correct operation of the devices. Special features are highlighted and discussed in more detail.



3. Overview

The KSR1 is designed for monitoring medium voltage and high voltage capacitors. Here, the device can be configured to monitor either the unbalance voltage or the unbalance current. As tripping limit, two values can be set (alarm/trip). All limits can be displayed or set as an absolute value or in percentage to the measuring range end value.

If a set alarm/trip limit is exceeded, the assigned relay is switched after the set delay time has been elapsed. Depending on the settings, an activated relay can be reset either automatically or manually.

An additional relay can be logically **AND** or **OR** linked to the alarm/trip relays. Furthermore, the KSR1 stores the last 5 alarms/trips in the alarm memory.

NOTE: The KSR1 operates with unsigned absolute values. Therefore, regardless of the direction of the change (increase or decrease), a positive value is displayed or monitored.

Simplified overview:

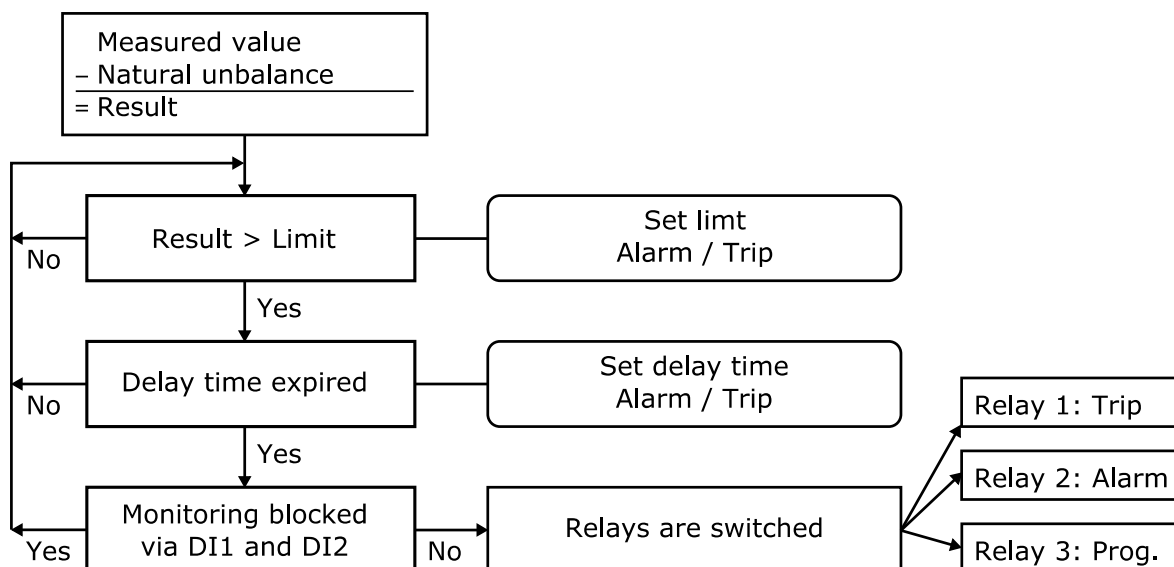



4. Application

High or medium voltage capacitors often use oil as dielectric, which can be fire in the event of a fault. For this reason, it is important to detect and timely react to a fault. This requires a permanent monitoring of the capacitors. Since, the voltage and the current change in the event of a fault, the unbalance voltage as well as the unbalance current can be monitored.

4.1 Unbalance voltage monitoring

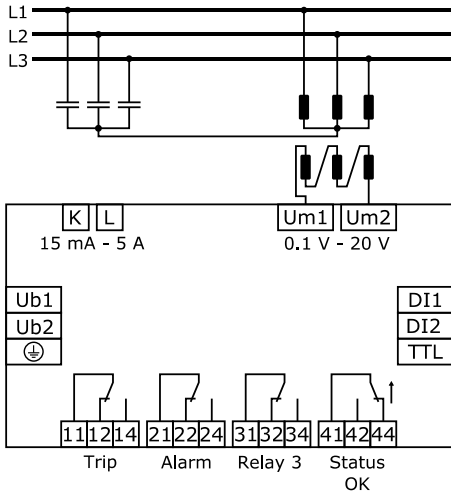

4.2 Unbalanced current monitoring

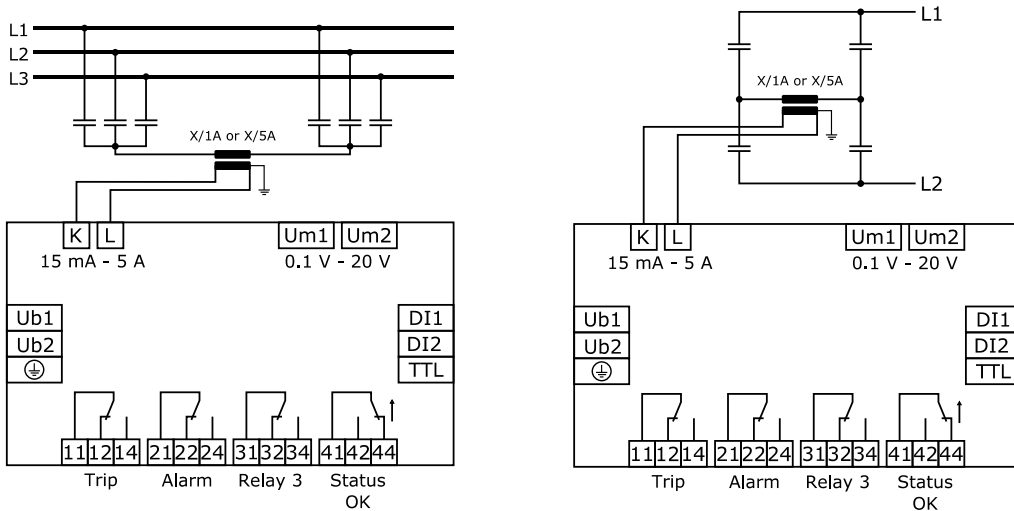



5. Terminals

5.1 Power supply

The KSR1 has a wide range power supply and can be operated with voltages of 40 – 250 V AC (45 – 65 Hz) and 40 – 300 V DC.

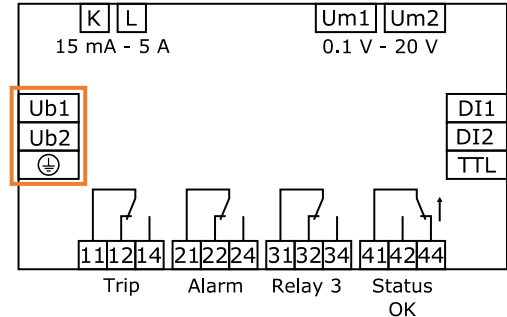

5.2 Inputs

5.2.1 Measurement input

The KSR1 has a current and voltage measuring input. The voltage measuring range is 0.1 – 20 V and the current measuring range 15 mA – 5 A.

Either the current or voltage can be monitored at the same time. It is not possible to monitor both inputs simultaneously.

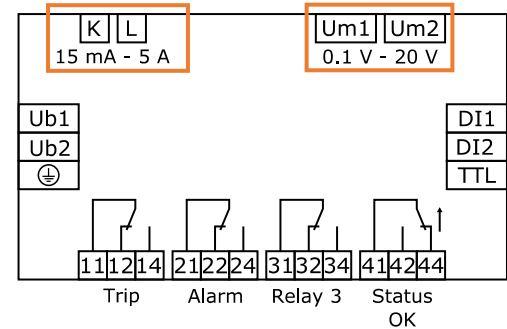

5.2.2 Digital input

The alarm system of the KSR1 can be blocked via the digital input. For this purpose, an external connection between DI1 and DI2 can be established or interrupted. The logic of the digital input can be freely selected.

⚠ CAUTION

Applying an external voltage to the terminals DI1 or DI2 can destroy the device.

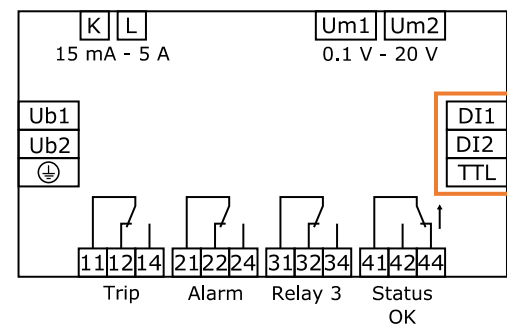

5.3 Outputs

The KSR1 includes 4 relay outputs.

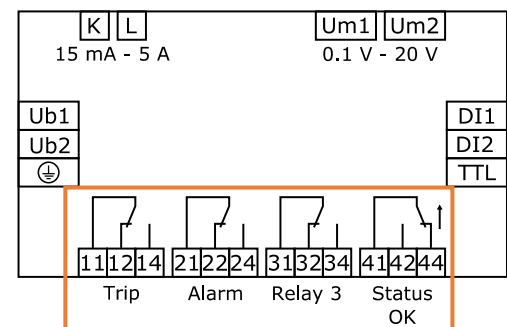



5.3.1 Trip relay

The trip relay operates with the change-over contacts 11-12/14. The contacts 11-12 are normally closed and 11-14 are normally opened (no trip condition). In case, the trip limit (voltage or current) is exceeded, for a longer period than **trt**, the contacts 11-14 will be closed and 11-12 will be opened.

5.3.2 Alarm relay

The trip relay operates with the change-over contacts 21-22/24. The contacts 21-22 are normally closed and 21-24 are normally opened (no alarm condition). In case, the alarm limit (voltage or current) is exceeded, for a longer period than **Alt**, the contacts 21-24 will be closed and 21-22 will be opened.

5.3.3 Relay 3

This relay can be set to work with alarm, trip **or** alarm or alarm **and** trip. Under normal conditions (no trip, no alarm), the contacts 31-32 are normally closed and 31-34 are normally opened. In an alarm/trip event, the contacts 31-34 will be closed and 31-32 will be opened.

5.3.4 Status relay

The KSR1 supervises its internal modules and software. If an internal malfunction is detected, the relay will open the contacts 41-44 and closes 41-42. Additional to switching the relay contact, the display shows **SyS** or **Prog**.

The relay is designed as life contact, in case of a missing power supply the contacts 41-42 are closed and contacts 41-44 are opened.



6. Operation

6.1.1 Operation concept

The device is operated via 4 keys. If no button is pushed within 60 s, the backlight turns off. To turn the backlight on again, any button can be pushed. Afterwards, the standard key functions are available again. Depending on the respective menu, the keys have different functions.

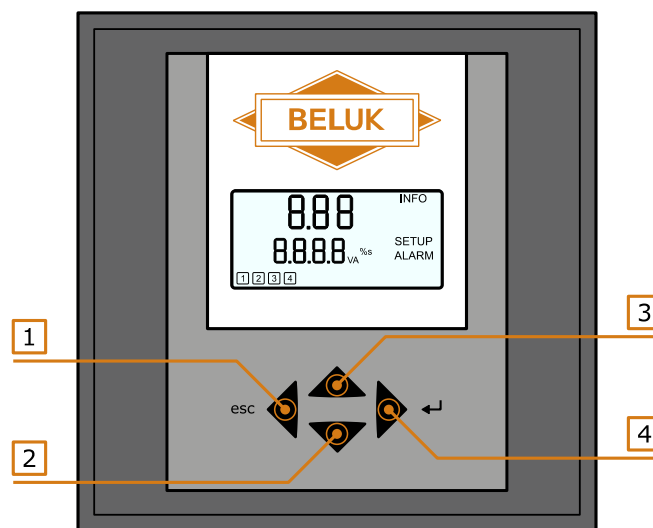

- | | |
|----------|---|
| 1 | <ul style="list-style-type: none"> ▪ Exit menu ▪ Move cursor to the left ▪ Reset alarm/trip (push for 3 s) |
| 2 | <ul style="list-style-type: none"> ▪ Decrease value ▪ Select next value or menu item |
| 3 | <ul style="list-style-type: none"> ▪ Increase value ▪ Select previous value or menu item |
| 4 | <ul style="list-style-type: none"> ▪ Open menu ▪ Move cursor to the right ▪ Accept value |



6.1.2 Input of numerical values

If a menu item has been entered, the first digit of the current value flashes. Numbers can be increased or decreased by pushing the ▲ and ▼ keys.

The next digit can be selected by pushing the ► key. In order to select the previous digit, the ◀ key must be pushed.

If the last digit (right) has been selected and the ► key is pushed again, a multiplier **k** (kilo) or **M** (mega) can be set using the ▲ and ▼ keys. To accept the value and complete the entry, the ► key must be pushed again.

If an entered value has not been accepted and another value is displayed after an input, the entered value has exceeded or fallen below the threshold of the setting range.

An entry can be canceled at any time by pushing the ◀ key. Depending on the actual position, the ◀ key must be repeatedly pushed until the first digit (left) is selected. Pushing the ◀ key again exits the menu item without accepting changes.



7. Display indications

7.1 General



The selected main menu appears on the right side of the display.

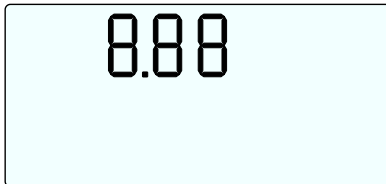

The first line shows the codes of the respective submenus and the abbreviations of the measured values.

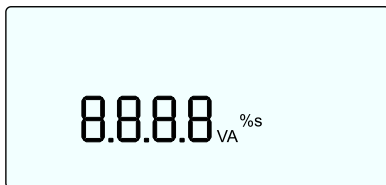

The second line shows the set and measured values.

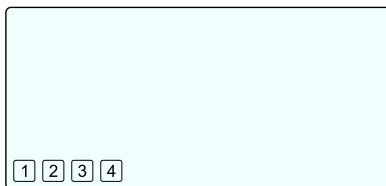

The last line indicates which output relay is activated.

7.2 Error messages

In case of an internal error, the message **lub Sys** or **lub Prog** is indicated and the status relay is switched. The KSR1 is defective and must be replaced.



8. Menus

8.1 INFO

In the **INFO** menu all set limits, alarm/trip delay times and the stored natural unbalance current/voltage can be retrieved.

To open the **INFO** menu, the menu must be selected with the ▼ key and entered by pushing the ► key. The subsequent menu items can be selected with the ▲ and ▼ keys.

- NU** Natural unbalance current/voltage
- Trd** Tripping limit
- Trt** Tripping delay time
- ALd** Alarm limit
- ALt** Alarm delay time
- Fr** Software version
- di** State of the digital input DI
 - The function is disabled, monitoring cannot be blocked
 - OPEN** The terminals DI1 and DI2 are not interconnected
 - CLSd** The terminals DI1 and DI2 are interconnected

8.2 SETUP

The **SETUP** menu is divided into two menu levels which are selected by entering the respective password.

- The **Quick Start menu** contains the basic settings required for commissioning
- The **Expert menu** contains all available settings of the KSR1

In order to open the **SETUP** menu, the menu must be selected using the ▼ key. The menu can be entered by pushing the ► key. After a successful password entry (**Quick Start menu 242** or **Expert menu 511**), the menu items can be selected with the ▲ and ▼ keys and entered with ►.

Quick Start menu: PIN 242

100 Start menu

NU Natural unbalance current/voltage of the capacitor bank

To store the unbalance current or voltage, the ► key must be pushed once. Afterwards, the second display line flashes and shows the currently measured value. To save the shown value, ► must be pushed again.

If a new value has to be stored, the ► key can be pushed again. The stored value of the unbalance current or the unbalance voltage is displayed in the **INFO** menu. The evaluation of the natural unbalance is done as absolute value. Thus, even if the measured current or voltage falls below the stored value, this is displayed and evaluated as an increase.

NOTE: Whether the unbalance voltage or the unbalance current has to be measured, can be defined in **SETUP 200/CUr**.

**trd** Limit Trip relay

This limit can be set as an absolute value or as a percentage of the nominal range of the current or voltage input (voltage 0.2 - 20 V / current 20 mA - 5 A). Using the factory setting, the limit must be entered as an absolute value.

NOTE: If the transformer factor is changed subsequently, this value is automatically adjusted to the set factor.

trt Delay time Trip relay

If the set limit of the trip relay is exceeded, the contact 11-14 is closed and contact 11-12 is opened after the set delay time.

ALd Limit Alarm relay

This limit can be set as an absolute value or as a percentage of the nominal range of the current or voltage input (voltage 0.2 - 20 V / current 20 mA - 5 A). Using the factory setting, the limit must be entered as an absolute value.

NOTE: If the transformer factor is changed subsequently, this value is automatically adjusted to the set factor.

ALt Delay time Alarm relay

If the set limit of the trip relay is exceeded, the contact 21-24 is closed and contact 21-22 is opened after the set delay time.

trL Keep switching state Trip relay

YES: The Trip relay remains active even after the trip condition is no longer present.

NO: The Trip relay returns to the inactive state after the trip condition is no longer present.

ALL Keep switching state Alarm relay

YES: The Alarm relay remains active even after the alarm condition is no longer present.

NO: The Alarm relay returns to the inactive state after the alarm condition is no longer present.

r3 Relay 3

It can be defined whether the Relay 3 is activated together with an alarm/trip or with both relays. The following settings are possible.

OFF: Relay 3 is switched off

A: Relay 3 is switched together with the Alarm relay

t: Relay 3 is switched together with the Trip relay

tnA: Relay 3 is switched if Alarm **and** Trip are active

tuA: Relay 3 is switched if Alarm **or** Trip are active

R3L Keep switching state Relay 3

YES: The Relay 3 remains active even after the alarm/trip condition is no longer present.

NO: The Relay 3 returns to the inactive state after the alarm/trip condition is no longer present.



Expert Menu : Passwort 511

100 Start menu

Contains the previously mentioned menu items as well.

200 Measurement menu

CUr Current measurement

YES: The KSR1 measures the current via the terminals **K** and **L**. Trip and alarm limits are displayed in amperes.

NO: The KSR1 measures the voltage via the terminals **UM1** and **UM2**. Trip and alarm limits are displayed in volts.

PEr Display in percent

YES: All values are displayed in percent. The alarm/trip limits must be entered as a percentage of the nominal range.

NO: All values are displayed as absolute values. Alarm/Trip limits must be entered as absolute values.

trF Transformer factor

Adjustable:

Current transformer factor: 1 – 4000

Voltage transformer factor: 1 – 350

Frq Frequency

Here, the power grid frequency can be adjusted. In order to guarantee a proper operation of the device, this setting must match the frequency of the supply net.

50: Must be set within 50 Hz power grids.

60: Must be set within 60 Hz power grids.

300 Alarm Menu

tr Activate trip alarm

YES: If the set trip limit is still exceeded after the delay time has been elapsed, the trip relay is switched and **trIP ALARM** flashes in the display.

NO: There is no reaction if the set limit is exceeded.

trS Store the trip value into alarm memory

YES: The highest trip value, during the delay time, is stored in the alarm memory.

NO: Trip values are not stored.

AL Activate alarm

YES: If the set alarm limit is still exceeded after the delay time has been elapsed, the trip relay is switched and **AL ALARM** flashes in the display.

NO: There is no reaction if the set limit is exceeded.



ALS	Store the alarm value into alarm memory YES: The highest alarm value, during the delay time, is stored in the alarm memory. NO: Alarm values are not stored.
dor	Hysteresis The hysteresis is adjustable within a range of 50 % – 100 %. The hysteresis defines a second limit which is used for resetting a trip/alarm. Examples: Case 1: The trip limit is 0.5 A and the hysteresis is 100 %. So, the trip is reset when the current drops below 0.5 A. Case 2: The trip limit is 0.5 A and the hysteresis is 50 %. So, the trip is reset when the current drops below 0.25 A. <div style="border: 1px solid black; padding: 5px;">NOTE: The KSR1 works with unsigned absolute values. Therefore, regardless of the direction of the change (increase or decrease of the measured value), a positive value is displayed or the limit is exceeded.</div>
di	Digital input YES: The monitoring system can be blocked via the digital input. NO: The monitoring system cannot be blocked via the digital input.
diL	Digital input logic YES: the monitoring system is blocked when the connection between terminals DI1 and DI2 is closed. NO: The monitoring system is blocked when the connection between terminals DI1 and DI2 is open. 400 Reset Menü
rtr	Reset trip If the trip condition is still pending, the trip cannot be reset.
rAL	Reset alarm If the alarm condition is still pending, the alarm cannot be reset.
rSE	Reset alarm memory
rNU	Reset the saved unbalance value
rFS	Factory reset
PS	Quick Start menu password Setting range: 000 – 999; Master password: 242
PE	Expert menu password Setting range: 000 – 999; Master password: 511. If the PIN is set to 000, all SETUP menus are unlocked.



8.3 ALARM

The alarm memory contains the last 5 alarms/trips. They are arranged in a way that the newest alarm can be found at the memory location 1 and the oldest at the memory location 5.

The alarm memory follows the first in and first out principle. If a new alarm is triggered, it is stored at the memory location 1. As a result, all previous entries (1 – 5) are moved to the next higher position. The alarm which was previously stored at memory location 5 is deleted.

The alarm memory is non-volatile and can be completely reset by simultaneously pushing the ▲ and ▼ keys (approx. 3 s) within the alarm menu. The alarm memory can also be deleted in **SETUP 400/rSE**.



9. Specifications

Supply	Voltage range: 40 – 250 V AC (45 – 65 Hz) or 40 – 300 V DC Power consumption: 5 VA Protection: 6 A
Voltage measuring	Voltage range: 0.1 – 20 V; Burden 240 kΩ Voltage transformer ratio: Adjustable 1 – 350 Overload: 120 V (continuous), 500 V (10 s) Accuracy: 0.5 % from upper measurement range
Current measuring	Current range: 15 mA – 5 A; Burden 20 mΩ Current transformer ratio: Adjustable 1 – 4000 Overload: 25 A (continuous), 100 A (1 s) Accuracy: 0.5 % from upper measurement range
Relay outputs	4 relays: Change-over contact; Potential-free; Max. protection 6 A Max. output rating AC: 1250 VA; Max. switching voltage: 440 V AC Max. output rating DC (ohmic): 30 V / 5 A 60 V / 1 A 110 V / 0.5 A 220 V / 0.3 A
Digital input	Blocking alarm/trip via digital input.
Interface	TTL; Rear (optional: TTL-USB converter)
Ambient temperature	Operation: -20 °C – 70 °C Storage: -40 °C – 85 °C
Humidity	0 % - 95 %, Without moisture condensation
Overvoltage class	CAT II; Pollution degree 3 (DIN VDE 0110, Teil 1 / IEC 60664-1)
Standards	DIN VDE 0110 part 1 (IEC 60664-1:1992) VDE 0411 part 1 (DIN EN 61010-1 / IEC 61010-1:2001) VDE 0843 part 20 (DIN EN 61326 / IEC 61326: 1997 + A1:1998 +A2: 2000)
Conformity and listing	CE
Connection	Screw terminals; Max. 2.5 mm ²
Casing	Front: Plastic housing (UL94-VO) Rear: Metal
Protection class	Front: IP50, (IP54 by using a gasket) Rear: IP20
Weight	ca. 0.65 kg
Dimensions	144 x 144 x 58 mm (h x w x d), Cutout 138 ^{+0,5} x 138 ^{+0,5} mm



10. Settings

Parameter	Range	Factory settings	Customer settings
Natural unbalanced NU			
Trip limit trd	20 mA – 5 A / 200 mV – 20 V	1 V / 1 A	
Trip delay time trt	0,1 – 150 s	0,5 s	
Alarm limit Ald	20 mA – 5 A / 200 mV – 20 V	5 V / 5 A	
Alarm delay time Alt	0,1 – 150 s	1,0 s	
Trip keep switching state trL		YES	
Alarm keep switching state ALL		YES	
Relays 3 r3		OFF	
Relay 3 keep switching state r3L		YES	
Current / voltage monitoring Cur		YES	
Display values in percent PEr		NO	
Transformer factor trF	CT 1 – 4000 / PT 1 – 350	1	
Power grid frequency Frq	50 / 60 Hz	50 Hz	
Activate Trip tr		YES	
Store trip in alarm memory trs		YES	
Activate Alarm AL		YES	
Store alarm in alarm memory ALS		YES	
Hysteresis dor	50 % – 100 %	90 %	
Activate digital input DI di		NO	
Digital input logic diL		NO	
Password Quick Start menu PS	000 – 999	242	
Password Expert menu PE	000 – 999	511	